

- ・・・筋交い 45×90
- ・・・筋交い 45×90 + 外部構造用合板 t12CN50外周@75、内部@150
- その他外部は構造用合板 t12 胴縁で止め

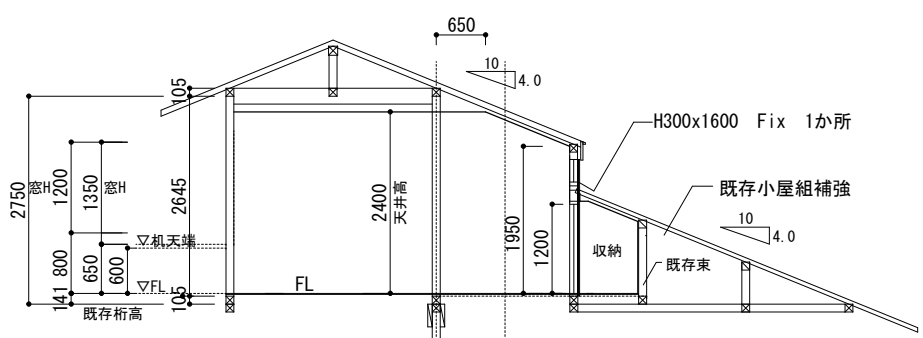

外壁がヨコバリから
タテバリに

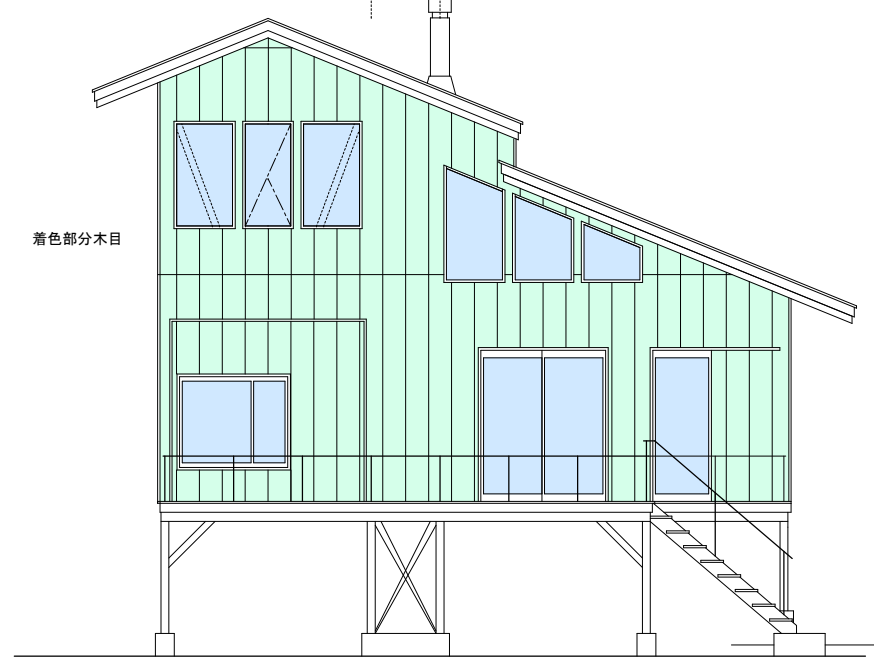

東立面図 S=1/100

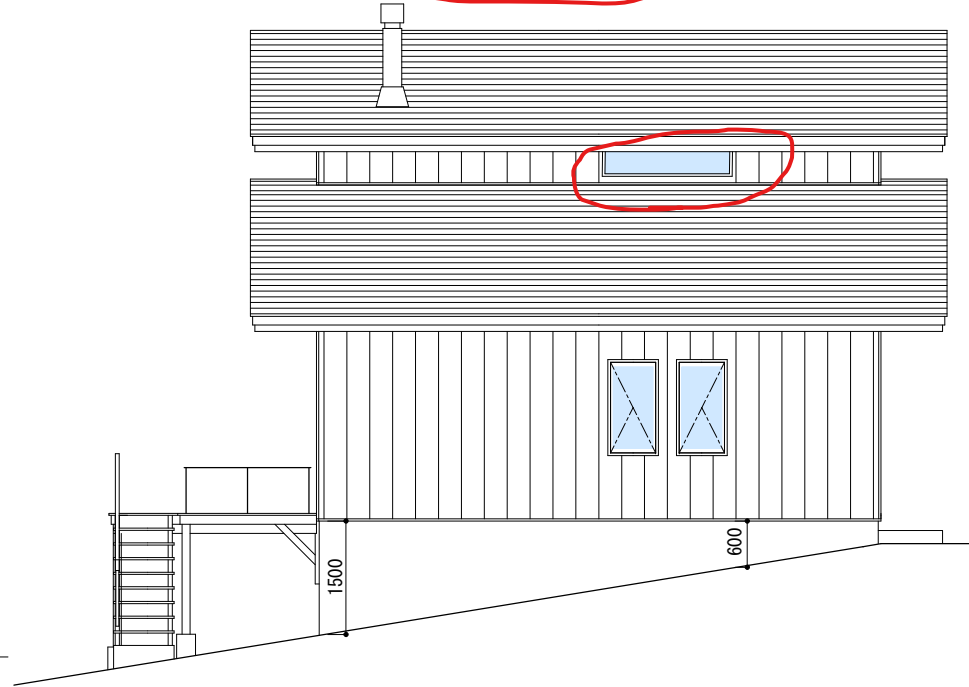

北立面図 S=1/100

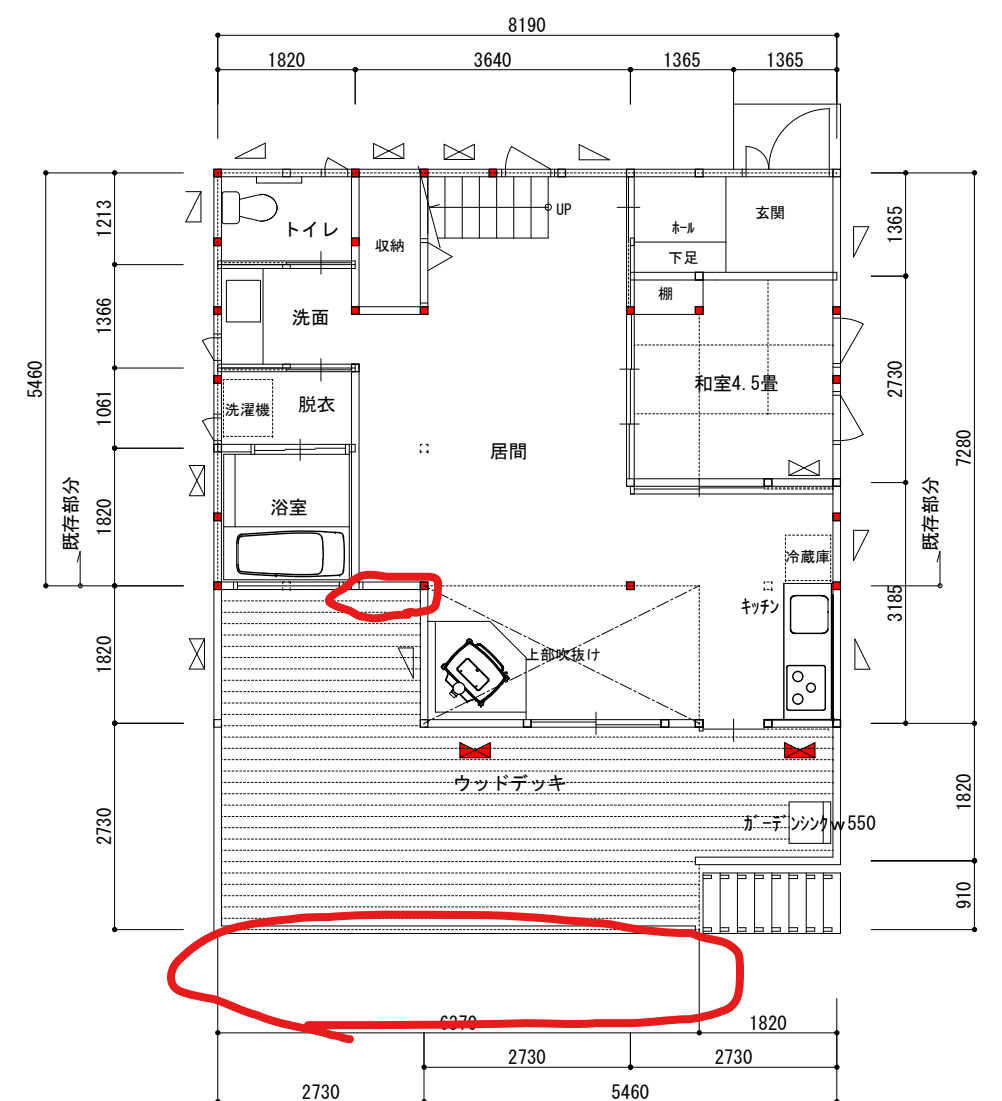

1階平面図 S=1/100

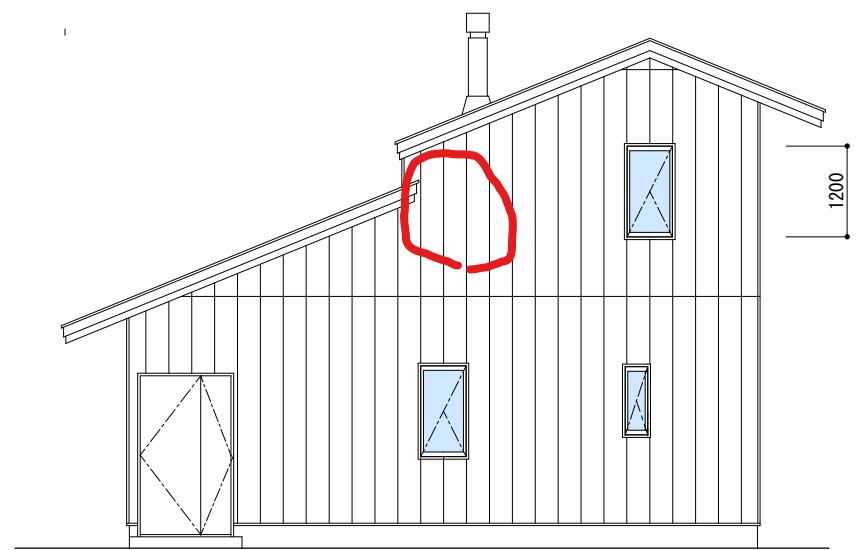

西立面図 S=1/100

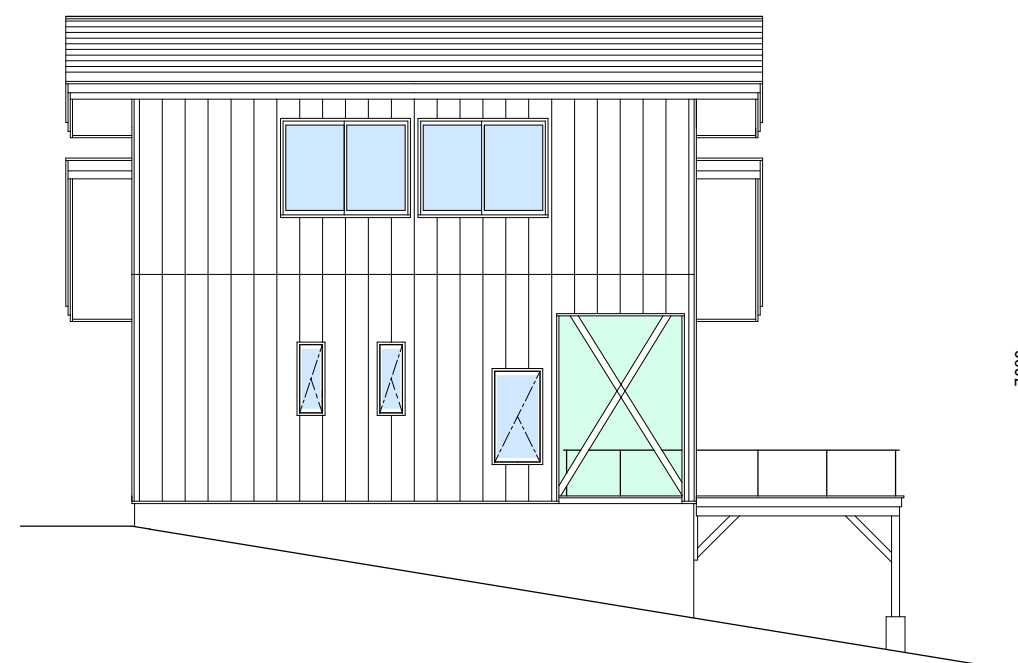

南立面図 S=1/100

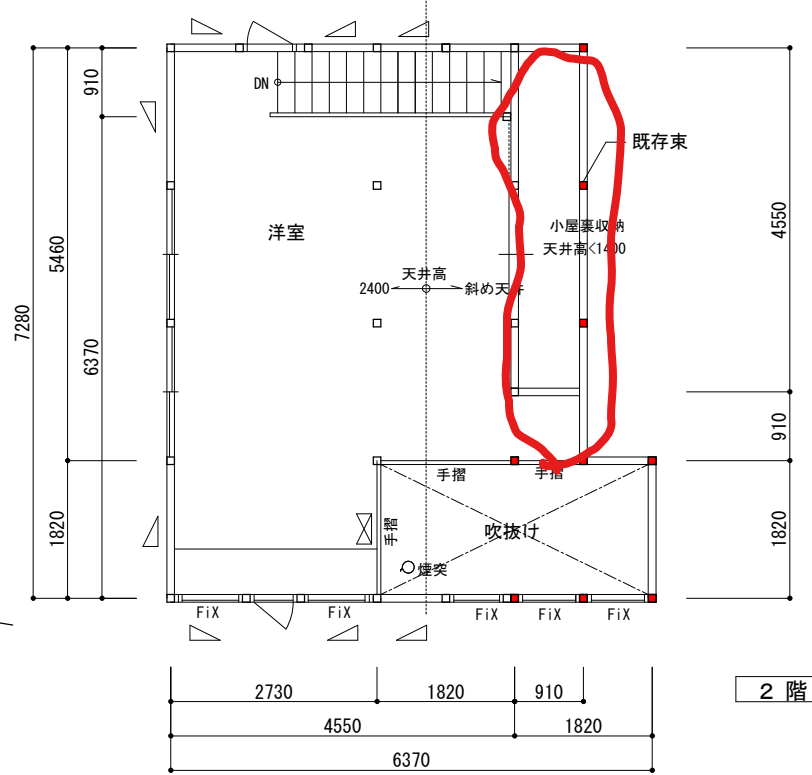

2階平面図 S=1/100